



8500601012

User manual
Bedienungsanleitung
Mode d'emploi
Handleiding
Manuale
Manual del usuario
Használati utasítás
Instrukcja obsługi

Korisnički priručnik
Navodila za uporabo
Návod k použití
Návod na použitie
Manual de utilizare
Användarhandbok
Brugervejledning
Manual do utilizador





Hello,
nice to meet you
we are

LUTECH

CONNECTED BY LIGHTING

Thank you !
For your purchase.

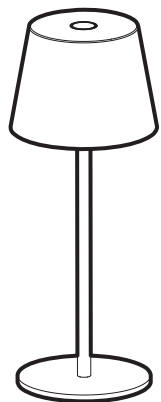

x 1

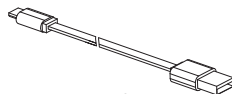

x 1

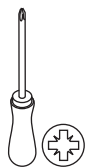

Technical Data

Supply Voltage: 5V 

LED (1.1W)

Bulb Type: The light source is only exchangeable by a professional.

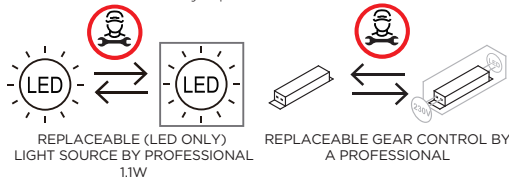

Battery: 1 x 3.7 VDC 2200 mAh Li-ion battery.



Conformity with all relevant EC Directive requirements.

IP54

Splash-proof



Class III product - designed to be supplied from a SELV (Separated or Safety Extra-Low Voltage) power source.



Waste electrical products should not be disposed of with household waste. Please recycle where facilities exist. Check with your Local Authority or local store for recycling advice.

Technische Daten

Versorgungsspannung: 5V 

LED (1.1W)

Leuchtmittel-Typ: Die Lichtquelle ist nur durch eine Fachkraft austauschbar.

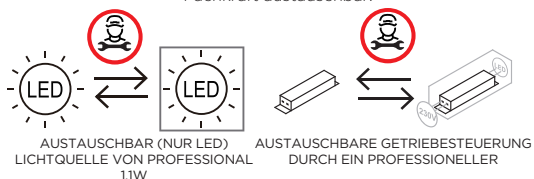

Batterie: 1 x 3.7 VDC 2200 mAh Li-ion batterie.



In Übereinstimmung mit allen einschlägigen EG Richtlinienanforderungen.

IP54

Spritzwassergeschützt



Schutzklasse III - zur Versorgung über eine Stromquelle mit Schutzkleinspannung (SELV) vorgesehen



Elektroaltgeräte dürfen nicht über den Hausmüll entsorgt werden. Bitte recyceln Sie Elektroaltgeräte bei Ihrem lokalen Wertstoffhof oder ausgewiesenen Sammelstellen.

Safety Instructions

EN

- You can consult the Safety Instructions on our website: www.lutec.com/service/safetyinstructions
- Please scan the QR code underneath. For your convenience you can find these Safety Instructions also in the box.



- This product is fully compliant to the ERP Regulation (EU) 2019/2020 and Amending Regulation (EU) 2021/341.
- Coastal areas are harsh on lamps as the high humidity and exposure to salt accelerates corrosion of the materials. Under these circumstances, we advise to clean your luminaire regularly with a dry cloth. (no detergents)
- This product contains a light source of energy efficiency class <D>.**

Sicherheitshinweise

DE

- Sie können die Sicherheitshinweise auf unserer Website nachlesen: www.lutec.com/service/safetyinstructions
- Scannen Sie bitte den QR-Code. Die Sicherheitshinweise sind auch in der Verpackung enthalten.



- Dieses Produkt entspricht der ERP-Verordnung (EU) 2019/2020 und der Änderungsverordnung (EU) 2021/341.
- Die hohe Luftfeuchtigkeit und die Einwirkung von Salz beschleunigen die Korrosion der Materialien in Küstengebieten. Unter diesen Umständen raten wir Ihnen, Ihre Leuchte regelmäßig mit einem trockenen Tuch zu reinigen. (keine Reinigungsmittel)
- Dieses Produkt enthält eine Lichtquelle der Energieeffizienzklasse <D>.**

Données techniques

Tension
d'alimentation: 5V 

Type
d'ampoule: LED (1.1W)
La source lumineuse peut uniquement
être remplacée par un spécialiste.

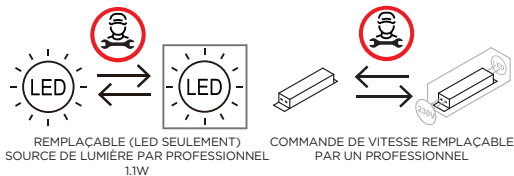

Pile: 1 x 3.7 VDC 2200 mAh Li-ion pile.

 Conforme à toutes les exigences de la directive CE.

IP54 Étanche aux éclaboussures

 Produit de classe III - Le luminaire fonctionne en très basse tension de sécurité (TBTs)

 Les produits électriques usagés ne doivent pas être jetés avec les ordures ménagères. Veuillez les recycler là où des installations existent. Vérifiez auprès de votre autorité locale ou de votre magasin local pour obtenir des conseils sur le recyclage.

Instructions de sécurité

- Vous pouvez consulter les consignes de sécurité sur notre site Internet : www.lutec.com/service/safetyinstructions
- Veuillez scanner le code QR situé en dessous. Pour votre commodité, vous trouverez également ces consignes de sécurité dans la boîte.



- Ce produit est entièrement conforme au règlement ERP (UE) 2019/2020 et au règlement modificatif (UE) 2021/341.
- Les zones côtières sont difficiles pour les lampes car l'humidité élevée et l'exposition au sel accélèrent la corrosion des matériaux. Dans ces conditions, nous vous conseillons de nettoyer régulièrement votre luminaire à l'aide d'un chiffon sec. (pas de détergents)
- **Ce produit contient une source lumineuse de classe d'efficacité énergétique <D>.**

Technische gegevens

Voedingsspanning: 5V 

Type lamp: LED (1.1W)
De lichtbron kan uitsluitend door een specialist of vakman worden vervangen.

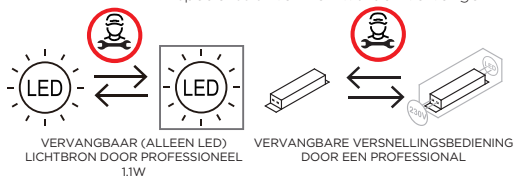

Accu: 1 x 3.7 VDC 2200 mAh Li-ion accu.

 Voldoet aan alle relevante eisen van de EG-richtlijn.

IP54 Spatwaterdicht

 Klasse III-product - ontworpen om geleverd door een SELV (gescheiden of Safety Extra-Low Voltage) stroombron.

 Afgedankte elektrische producten mogen niet met het huisvuil worden weggegooid. Gelieve te recycleren waar er faciliteiten bestaan. Neem contact op met uw gemeente of plaatselijke winkel voor advies over recycling.

Veiligheidsinstructies

- U kunt de veiligheidsinstructies raadplegen op onze website: www.lutec.com/service/safetyinstructions
- Gelieve de QR-code hieronder te scannen. Voor uw gemak kunt u deze veiligheidsinstructies ook in de doos vinden.



- Dit product is volledig in overeenstemming met de ERP-verordening (EU) 2019/2020 en wijzigingsverordening (EU) 2021/341.
- Kustgebieden zijn zwaar voor lampen omdat de hoge luchtvochtigheid en de blootstelling aan zout de corrosie van de materialen versnelt. Onder deze omstandigheden adviseren wij om uw armatuur regelmatig schoon te maken met een droge doek. (geen schoonmaakmiddelen)
- **Dit product bevat een lichtbron van energie-efficiëntieklasse <D>.**

Dati tecnici

Tensione di alimentazione: 5V 

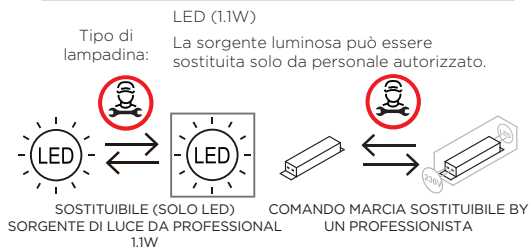

Batteria: 1 x 3.7 VDC 2200 mAh Li-ion batteria.



Conformità a tutti i requisiti della direttiva CE.

IP54

A prova di getti d'acqua



Prodotto di classe III - progettato per essere fornito da un SELV (Separato o Alimentazione di sicurezza a bassissima tensione).



I prodotti elettrici di scarto non devono essere smaltiti con i rifiuti domestici. Si prega di riciclare dove esistono strutture. Verificare con le autorità locali o con il negozio locale per consigli sul riciclaggio.

Istruzioni di sicurezza

- È possibile consultare le istruzioni di sicurezza sul nostro sito web: www.lutec.com/service/safety/instructions
- Si prega di scansionare il codice QR sottostante. Per vostra comodità potete trovare queste istruzioni di sicurezza anche nella scatola.



- Questo prodotto è pienamente conforme al regolamento ERP (UE) 2019/2020 e al regolamento di modifica (UE) 2021/341.
- Le zone costiere sono difficili per le lampade, poiché l'elevata umidità e l'esposizione alla salsedine accelerano la corrosione dei materiali. In queste circostanze, si consiglia di pulire regolarmente l'apparecchio con un panno asciutto. (senza detersivi)
- Questo prodotto contiene una sorgente luminosa di classe di efficienza energetica <D>.**

Datos técnicos

Tensión de alimentación: 5V 

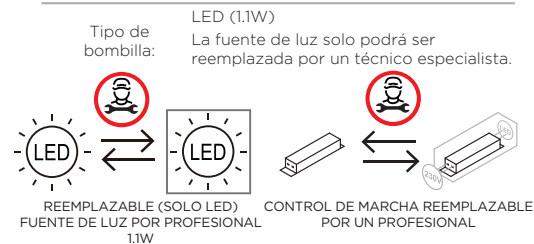

Pila: 1 x 3.7 VDC 2200 mAh Li-ion pila.



Conformidad con todos los requisitos pertinentes de la Directiva CE.

IP54

A prueba de salpicaduras



Clase III - La luminaria funciona con una fuente de tensión SELV



Los residuos de productos eléctricos no deben desecharse con la basura doméstica. Por favor, recicle donde existan instalaciones. Consulte a las autoridades locales o a la tienda local para obtener consejos sobre el reciclaje en las instalaciones correspondientes.

Instrucciones de seguridad

- Puede consultar las instrucciones de seguridad en nuestra página web: www.lutec.com/service/safety/instructions
- Por favor, escanee el código QR que aparece debajo. Para su comodidad puede encontrar estas Instrucciones de Seguridad también en la caja.



- Este producto cumple totalmente con el Reglamento ERP (UE) 2019/2020 y el Reglamento Modificatorio (UE) 2021/341.
- Las zonas costeras son duras para las lámparas, ya que la elevada humedad y la exposición a la sal aceleran la corrosión de los materiales. En estas circunstancias, aconsejamos limpiar la luminaria regularmente con un paño seco. (sin detergentes)
- Este producto contiene una fuente de luz de clase de eficiencia energética <D>.**

Műszaki adatok

Tápfeszültség: 5V 

Izzó típusa: LED (1.1W)
A fényforrást csak szakember cserélheti

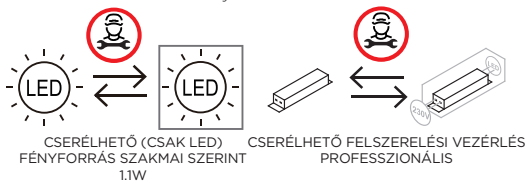

Akkumulátor: 1 x 3.7 VDC 2200 mAh Li-ion akkumulátor.



Megfelel az összes vonatkozó EK-irányelv követelményeinek.

IP54

Fröccsenő víz ellen védett



III. Osztályú termék - úgy tervezték, hogy SELV-től (külön vagy Biztonsági rendkívül alacsony feszültségű) áramforrás.



Az elektromos termékek hulladékát nem szabad a háztartási hulladékkal együtt ártalmatlanítani. Kérjük, hogy ahol van erre lehetőség, ott hasznosítsák újra a terméket. Újrahasznosítási tanácsokért érdeklődjön a helyi hatóságnál vagy a helyi üzletben.

Biztonsági utasítások

- A biztonsági utasításokat a weboldalunkon tekintheti meg: www.lutec.com/service/safetyinstructions
- Kérjük, olvassa be az alatta lévő QR-kódot. Az Ön nyelme érdekében ezeket a Biztonsági utasításokat a dobozban is megtalálja.



- Ez a termék teljes mértékben megfelel az ERP (EU) 2019/2020 rendeletnek és az (EU) 2021/341 módosító rendeletnek.
- A tengerparti területek kíméletlenek a lámpák számára, mivel a magas páratartalom és a sónak való kitettség felgyorsítja az anyagok korrózióját. Ilyen körülmények között azt tanácsoljuk, hogy rendszeresen tisztítsa meg a lámpatestet száraz ruhával. (tisztítószerrel nem)
- Ez a termék <D> energiatékonysági osztályba tartozó fényforrást tartalmaz.**

Dane techniczne

Napięcie zasilania: 5V 

Typ żarówki: LED (1.1W)
Źródło światła może być wymieniane tylko przez specjalistę.

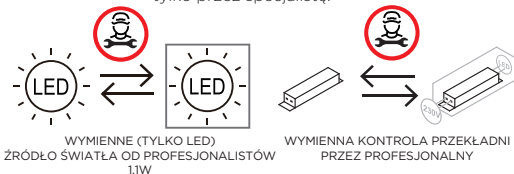

Bateria: 1 x 3.7 VDC 2200 mAh Li-ion bateria.



Zgodność z wszystkimi odpowiednimi wymogami Dyrektywy WE.

IP54

Odporna na zachlapanie



Produkt klasy III - zaprojektowany, aby być dostarczane z SELV (oddzielne lub Bezpieczne źródło zasilania o bardzo niskim napięciu).



Zużytych produktów elektrycznych nie należy wyrzucać razem z odpadami domowymi. Proszę podać je recyklingowi tam, gdzie istnieją takie możliwości. W celu uzyskania informacji na temat recyklingu należy skontaktować się z władzami lokalnymi lub lokalnym sklepem.

Instrukcje bezpieczeństwa

- Instrukcje bezpieczeństwa można znaleźć na naszej stronie internetowej: www.lutec.com/service/safetyinstructions
- Proszę zeskanować kod QR znajdujący się pod spodem. Dla Państwa wygody Instrukcje Bezpieczeństwa można znaleźć również w pudełku.



- Ten produkt jest w pełni zgodny z rozporządzeniem ERP (UE) 2019/2020 i rozporządzeniem zmieniającym (UE) 2021/341.
- Obszary przybrzeżne są trudne dla lamp, ponieważ wysoka wilgotność i ekspozycja na sól przyspieszają korozję materiałów. W takich okolicznościach zalecamy regularne czyszczenie oprawy oświetleniowej.
- Ten produkt zawiera źródło światła o klasie efektywności energetycznej <D>.**

Tehnički podaci

Napon napajanja: 5V 

LED (1.1W)

Vrsta žarulje: Izvor svjetla može zamijeniti samo stručnjak

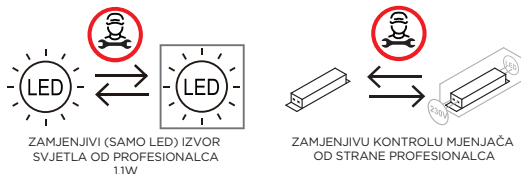

Baterija: 1 x 3.7 VDC 2200 mAh Li-ion baterija.



Sukladno sa svim relevantnim EU propisima i direktivama.

IP54

Otpornost na prskanje



Proizvod klase III - namijenjeno da se napaja sa odvojenim ili vrlo niskim naponom napajanja (SELV)



Električni otpad ne smije se odlagati zajedno sa kućnim otpadom. Može se odlagati na za to odgovarajućim mjestima. Za savjet o načinu zbrinjavanja obratite se nadležnom lokalnom uredu ili trgovini.

Tehnički podatki

Napajalna napetost: 5V 

LED (1.1W)

Vrsta žarnice: Svetlobni vir lahko zamenja le strokovnjak

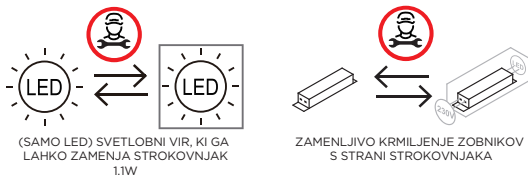

Baterija: 1 x 3.7 VDC litij-ionska baterija 2200 mAh.



Skladnost z vsemi ustreznimi predpisi direktive ES.

IP54

Odpornost na škropljenje z vodo



Izdelek razreda III - zasnovan za napajanje iz vira SELV (ločena dodatna niskonapetostna varnost).



Električnih odpadkov ne smete odlagati skupaj z gospodinjstvi odpadki. Reciklirajte jih tam, kjer so na voljo ustrezne naprave. Za nasvete o načinu recikliranja se obrnite na lokalne oblasti ali lokalno trgovino.

Sigurnosne upute

- Sigurnosne upute možete pronaći na našoj web stranici: www.lutec.com/service/safetyinstructions
- Skenirajte QR kod u nastavku. Za vašu udobnost u kutiji ćete pronaći i ove sigurnosne upute.



- Ovaj proizvod je u potpunosti usklađen s ERP Uredbom (EU) 2019/2020, i izmjeni Uredbe (EU) 2021/341.
- Obalna područja oštra su za lampe jer visoka vlažnost i izloženost soli ubrzavaju koroziju materijala. U takvim okolnostima savjetujemo da redovito čistite svoju svjetiljku suhom krpom. (bez deterdženata).
- **Ovaj proizvod sadrži izvor svjetlosti klase energetske učinkovitosti <D>.**

Varnostna navodila

- Varnostna navodila si lahko ogledate na našem spletnem mestu: www.lutec.com/service/safetyinstructions
- Prosimo, poskenirajte spodnjo kodo QR. Za vaše udobje ta varnostna navodila najdete tudi v škatli.



- Ta izdelek je v celoti skladen z uredbo o ERP (EU) 2019/2020 in Uredbo o spremembi Uredbe (EU) 2021/341.
- Obalna območja so zahtevna za svetilke, saj visoka vlažnost in izpostavljenost soli pospešujeta korozijo materialov. V teh okoliščinah svetujemo, da svetilko redno čistite s suho krpo. (brez detergentov)
- **Ta izdelek vsebuje svetlobni vir razreda energetske učinkovitosti <D>.**

Technická data

Napájecí napětí: 5V 

Typ žárovky: LED (1.1W)
Zdroj světla je pouze
vyměnitelný odborníkem

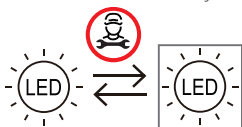

VYMĚNITELNÉ (POUZE LED) SVĚTLÝ ZDROJ PODLE PROFESIONÁLNÍ 1.1W



VYMĚNITELNÉ OVLÁDÁNÍ PŘEVODOVKY PROFESIONÁLEM

Baterie: 1 x 3.7 VDC 2200 mAh Li-ion baterie.



Shoda se všemi příslušnými předpisy ESpožadavky směrnice.

IP54

Odolnost proti stříkající vodě



Výrobek třídy III - určený k tomu, aby byl napájen ze zdroje SELV (odděleného Bezpečnostní extra nízké napětí).



Elektroodpad by se nemel likvidovat společně s domovním odpadem. Recyklujte je tam, kde jsou k dispozici zařízení. Informujte se na místním úrade nebo místním obchode kde vám poradí, jak recyklovat.

Bezpečnostní Instrukce

CZ

- Bezpečnostní pokyny naleznete na našich webových stránkách: www.lutec.com/service/safetyinstructions
- Naskenujte prosím QR kód pod ním. Pro vaše pohodlí najdete tyto bezpečnostní pokyny také v krabici.



- Tento výrobek je plně v souladu s nařízením ERP (EU) 2019/2020, a pozměňujícího nařízení (EU) 2021/341.
- Pobřežní oblasti jsou pro svítidla náročné, protože vysoká vlhkost a působení soli urychlují korozi materiálů. Za těchto okolností doporučujeme svítidlo pravidelně čistit suchým hadříkem. (bez čisticích prostředků)
- Tento výrobek obsahuje světelný zdroj třídy energetické účinnosti <D>.**

Technické údaje

Napájecí napětí: 5V 

Typ žárovky: LED (1.1W)
Světelný zdroj může vymenit len odborník

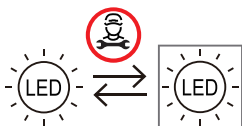

(LEN LED) SVĚTLÝ ZDROJ VYMĚNITELNÝ ODBORNÍKOM 1.1W



VYMĚNITELNÉ OVLÁDÁNIE PŘEVODOVKY PROFESIONÁLOM

Baterie: 1 x 3.7 VDC 2200 mAh Li-ion batéria.



Súlud so všetkými príslušnými nariadeniami smernice ES.

IP54

Odolnosť voči striekajúcej vode



Výrobek triedy III - určený na napájanie zo zdroja SELV (oddelené bezpečnostné mimoriadne nízke napätie).



Elektrický odpad by sa nemal likvidovať spolu s domovým odpadom. Recyklujte ich tam, kde sú k dispozícii zariadenia. Informujte sa na miestnom úrade alebo v miestnom obchode o spôsobe recyklácie.

Bezpečnostné inštrukcie

SK

- Bezpečnostné pokyny nájdete na našej webovej stránke: www.lutec.com/service/safetyinstructions
- Naskenujte QR kód pod ním. Pre vaše pohodlie nájdete tieto Bezpečnostné pokyny aj v krabici.



- Tento výrobek je plně v súlade s nariadením o ERP (EÚ) 2019/2020 a pozmeňujúcim nariadením (EÚ) 2021/341.
- Pobřežní oblasti sú pre lampy náročné, pretože vysoká vlhkost a pôsobenie soli urychlujú koroziu materiálov. Za týchto okolností odporúčame svietidlo pravidelne čistiť suchou handričkou. (bez čistiacich prostriedkov)
- Tento výrobek obsahuje svetelný zdroj triedy energetické účinnosti <D>.**

Date tehnice

Tensiunea de alimentare : 5V 

Tipul becului: LED (1.1W)
Sursa de lumină poate fi înlocuită numai de către un expert.

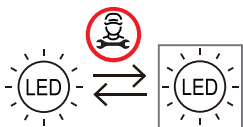

(NUMAI CU LED) SURSA DE LUMINĂ POATE FI ÎNLOCUITĂ DE UN PROFESIONIST
1.1W

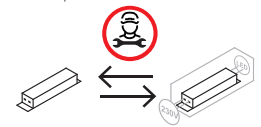

CONTROL AL ANGINAJULUI ÎNLOCUIBIL DE CĂTRE UN PROFESIONIST

Baterie: 1 x 3.7 VDC 2200 mAh Li-ion baterie.



Respectarea tuturor reglementărilor relevante ale Directivei CE.

IP54

Rezistență la stropirea cu apă



Produs de clasa III - conceput pentru a fi alimentat de la o sursă SELV (Separate Safety Extra Low Voltage).



Deșeurile electrice nu trebuie aruncate împreună cu deșeurile menajere. Reciclați-le acolo unde sunt disponibile facilități. Verificați la autoritatea locală sau la magazinul local pentru metodele de reciclare.

Tekniska data

Spänning för strömförsörjning: 5V 

Typ av glödlampa: LED (1.1W)
Ljuskällan kan endast bytas ut av en fackman

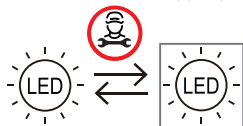

UTBYTBAR (ENDAST LED) LJUSKÄLLA FÖR PROFESSIONELLT BRUK
1.1W

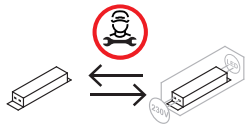

UTBYTBAR VÄXEL KONTROLLERAD AV EN YRKESMAN

Batteri: 1 x 3.7 VDC 2200 mAh Li-ion bateri.



överensstämmelse med alla relevanta krav i EG-direktivet

IP54

Stänkskyddad



Klass III-produkt - avsedd för SELV-strömförsörjning (extra låg signalspänning).



Elektriskt avfall får inte slängas tillsammans med hushållsavfall. Återvinn där det finns möjlighet. kontakta din lokala myndighet eller lokala butik för information om återvinningsmetoder.

Instrucțiuni de siguranță

RO

- Pentru instrucțiuni de siguranță, vă rugăm să vizitați site-ul nostru web: www.lutec.com/service/safetyinstructions
- Scanați codul QR de mai jos. Pentru comoditate dvs., veți găsi și aceste instrucțiuni de siguranță în cutie.



- Acest produs este pe deplin conform cu Regulamentul ERP (UE) 2019/2020 și cu Regulamentul de modificare (UE) 2021/341.
- Zonele de coastă sunt dure pentru lămpi, deoarece umiditatea ridicată și expunerea la sare accelerează coroziunea materialelor. În aceste condiții, vă sfătuim să vă curățați periodic corpul de iluminat cu o cârpă uscată. (fără detergenți)
- **Acest produs conține sursă de lumină din clasa de eficiență energetică <D>.**

Säkerhetsföreskrifter

SE

- Säkerhetsanvisningar hittar du på vår hemsida: www.lutec.com/service/safetyinstructions
- Vänligen skanna QR-koden nedan. För din bekvämlighet finns dessa säkerhetsanvisningar också i lådan.



- Denna produkt överensstämmer helt med ERP-förordningen (EU) 2019/2020 och förordningen om ändring av förordning (EU) 2021/341.
- Kustområden är tuffa för lampor eftersom den höga luftfuktigheten och exponeringen exponering för salt påskyndar korrosion av materialen. Under dessa omständigheter rekommenderar vi att du rengör din armatur regelbundet med en torr trasa. (inga rengöringsmedel)
- **Denna produkt innehåller en ljuskälla med energieffektivitetsklass <D>.**

Tekniske data

Forsynings-spænding: 5V 

LED (1.1W)

Pære type: Lyskilden kan kun udskiftes af en fagmand

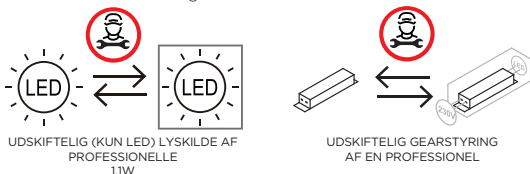

UDSKIFTELIG (KUN LED) LYSKILDE AF PROFESSIONELLE I.1W

UDSKIFTELIG GEARSTYRING AF EN PROFESSIONEL

Batteri: 1 x 3,7 VDC 2200 mAh Li-ion batteri.



Overensstemmelse med alle relevante EF-direktivkrav

IP54

Stænkstæt



Klasse III-produkt - designet til SELV-strømforsyning (separat ekstra lavspændingssikkerhed).



Elektrisk affald må ikke bortskaffes sammen med husholdningsaffald. Genbrug, hvor der er faciliteter til det. Spørg de lokale myndigheder eller den lokale butik om genbrugsmetoder.

Dados técnicos

Tensão de alimentação: 5V 

LED (1.1W)

Tipo de lâmpada: A fonte de luz só pode ser substituída por um profissional

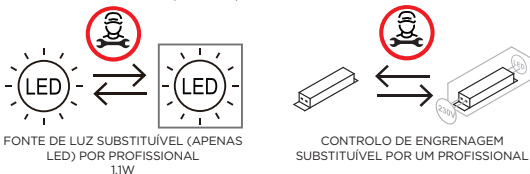

FORNTE DE LUZ SUBSTITUÍVEL (APENAS LED) POR PROFISSIONAL I.1W

CONTROLO DE ENGENHAGEM SUBSTITUÍVEL POR UM PROFISSIONAL

Bateria: 1 x 3,7 VDC 2200 mAh Li-ion bateria.



Conformidade com todos os requisitos pertinentes da diretiva CE

IP54

À prova de salpicos



Produto de classe III - concebido para ser alimentado por uma fonte SELV (segurança extra de baixa tensão separada).



Os resíduos eléctricos não devem ser eliminados juntamente com o lixo doméstico. Recicle onde houver instalações disponíveis. Informe-se junto das autoridades locais ou da loja local sobre os métodos de reciclagem.

Sikkerhedsinstruktioner

DK

- Sikkerhedsanvisningerne findes på vores hjemmeside: www.lutec.com/service/safetyinstructions
- Scan venligst QR-koden nedenfor. For nemheds skyld kan disse sikkerhedsinstruktioner også findes i kassen.



- Dette produkt er i fuld overensstemmelse med ERP-forordningen (EU) 2019/2020 og forordningen om ændring af forordning (EU) 2021/341.
- Kystområder er barske for lamper, da den høje luftfugtighed og eksponering for salt fremskynder korrosion af materialerne. Under disse omstændigheder anbefaler vi, at du rengør dit armatur regelmæssigt med en tør klud. (ingen rengøringsmidler)
- **Dette produkt indeholder en lyskilde i energieffektivitetsklasse <D>.**

Instruções de segurança

PT

- As instruções de segurança podem ser consultadas no nosso sítio Web: www.lutec.com/service/safetyinstructions
- Para sua conveniência, estas instruções de segurança também podem ser encontradas na caixa.



- Este produto está totalmente em conformidade com o Regulamento ERP (UE) 2019/2020 e o Regulamento que altera o Regulamento (UE) 2021/341.
- As zonas costeiras são duras para as lâmpadas, uma vez que a elevada humidade e a exposição ao sal acelera a corrosão dos materiais. Nestas circunstâncias, aconselhamos a limpeza regular da sua luminária com um pano seco. (sem detergentes)
- **Deste produto contém uma fonte de luz da classe de eficiência energética <D>.**

Function

Funktion/Fonction/Función/Funzione/Functie
Funkcja/Funkció/Funkcija/Funkcijo/Funkce
Funkciu/Funçã/Funktion/Funktion/Função

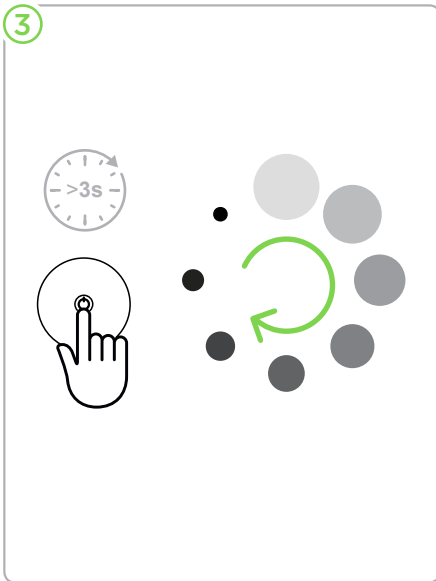
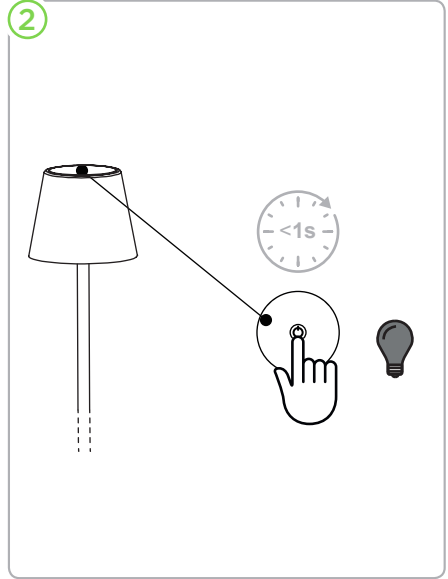
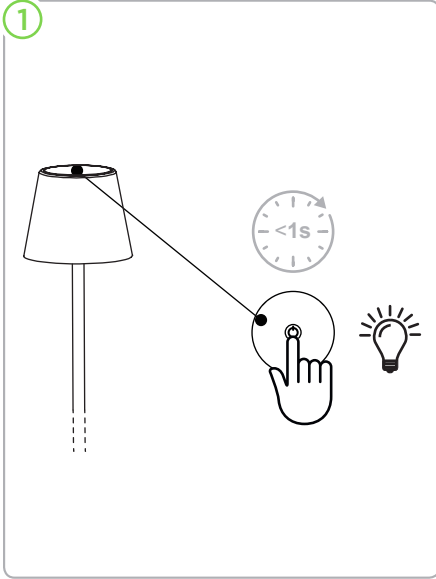

Charging

Aufladung/Charge/Opladen/Ricarica/Cargando
Töltés/Ładowanie/Punjenje/Polnjenje/Nabíjení
Nabíjanie/Încărcare/Laddning/Opladning/Cobrança

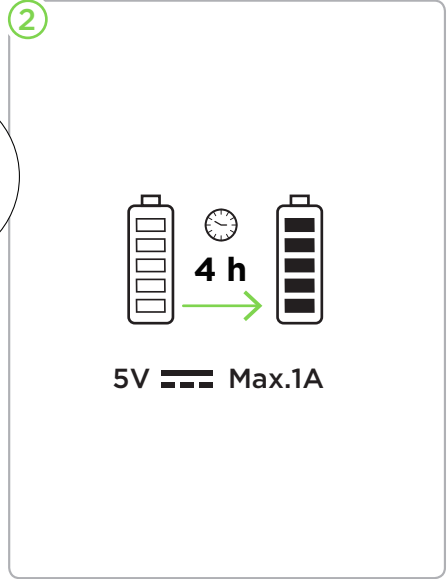
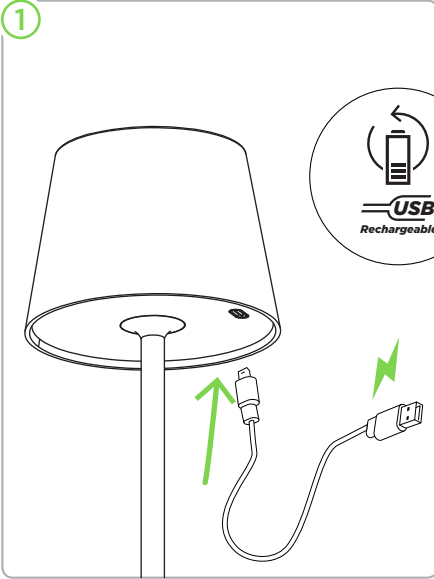

Battery Change

Batteriewechsel/Changement de la batterie
Batterijwissel/Sostituzione della batteria
Cambio de batería/Elemcsere/Wymiana baterii
Promjena baterije/Menjava baterije/Výměna
baterie/Výměna batérie/Schimbarea bateriei
Byte av batteri/Batteriskift/Mudança de bateria

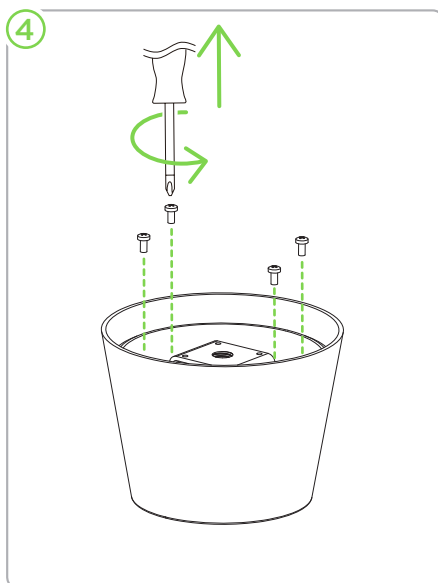
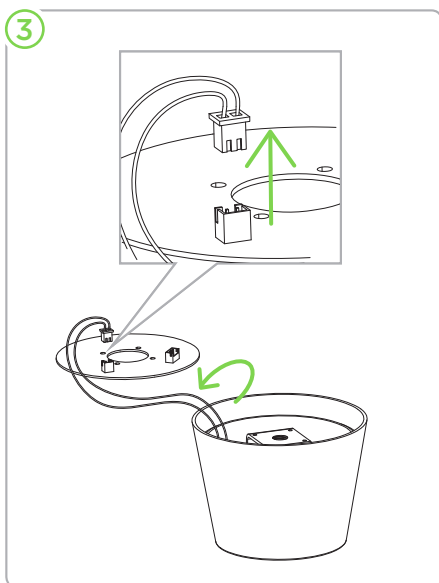
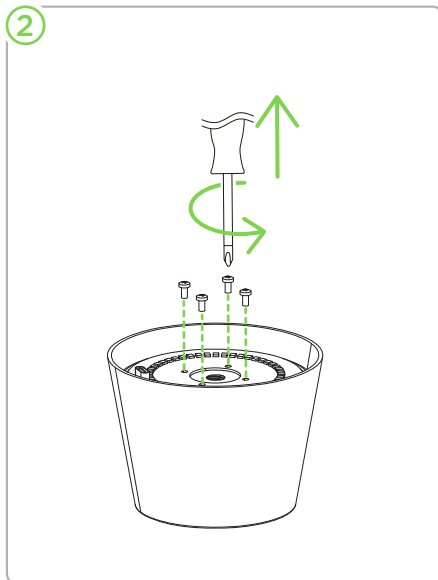
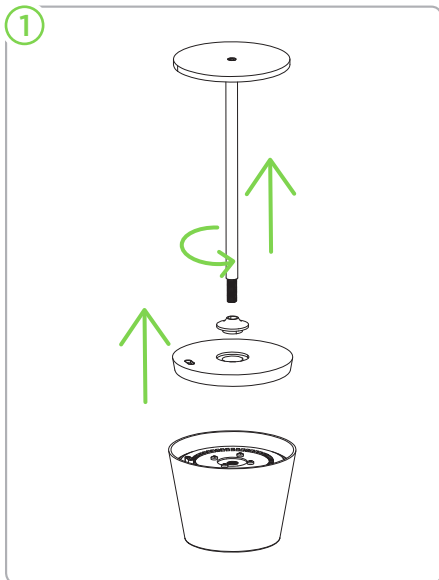

5

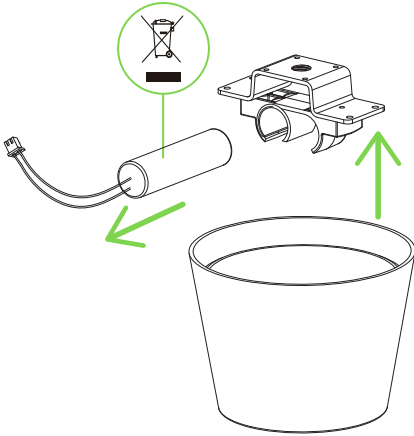

6

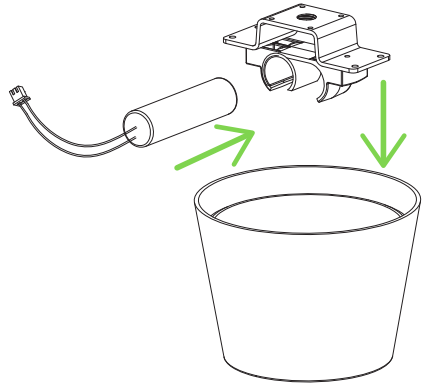

7

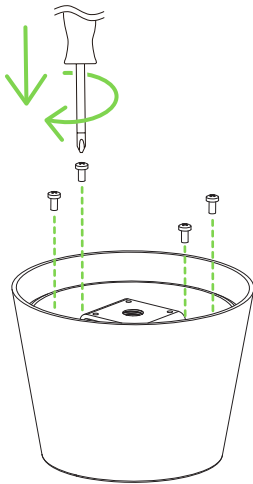

8

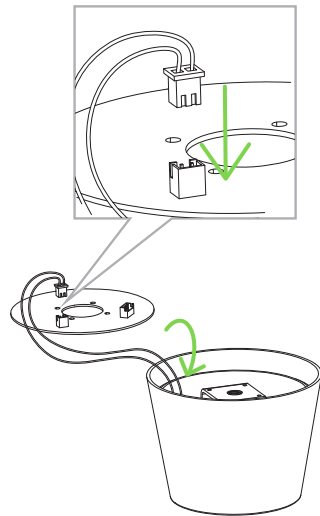

9

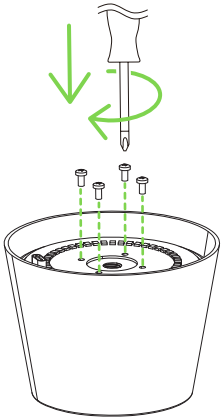

10

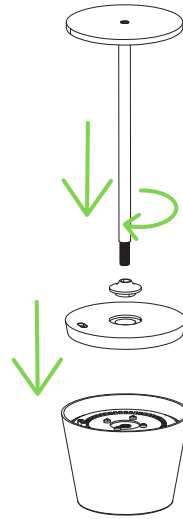

Have fun with your new lighting

LUTEC

CONNECTED BY LIGHTING

LUTEC Europe NV
Herentalsebaan 425
B-2160 Wommelgem
Belgium
+32 3 284 51 62
info@lutec-europe.com

LUTEC UK Ltd
110 Brooker Road
EN9 1JH Waltham Abbey
United Kingdom

LUTEC USA LLC
149B Houston Rd
Troutman NC 28166, USA
+877-714-8669
support@lutec.com

LUTEC China Head Office
CN8, Far-East Industry Park
Yuyao, Zhejiang
China

DESIGNED IN EUROPE, MADE IN CHINA

www.lutec.com
www.lutec.com/services/global-network



FR
Cet appareil
et ses batteries
primaires sont
recyclables **

À DÉPOSER
EN MAGASIN

OU

À DÉPOSER
EN DÉCHÈTERIE

Points de collecte sur www.quefairedemesdechets.fr

- DE** Das Gerät inklusive Batterie sind recycelbar **
- UK** This device and its primary batteries are recyclable **
- NL** Dit toestel en zijn primaire batterijen zijn recycleerbaar **
- IT** Questo apparecchio e le sue batterie primarie sono riciclabili **
- ES** Este dispositivo y sus baterías primarias son reciclables **
- HU** Ez a készülék és elsődleges akkumulátorai újrahasznosíthatók **
- PL** To urządzenie i jego baterie podstawowe nadają się do recyklingu **
- HR** Ovak uređaj i njegove primarne baterije mogu se reciklirati **
- SL** To napravo in njene primarne baterije je mogoče reciklirati **
- CZ** Toto zařízení a jeho primární baterie jsou recyklovatelné **
- SK** Toto zariadenie a jeho primárne batérie sú recyklovateľné **
- RO** Acest dispozitiv și bateriile sale primare sunt reciclabile **
- SE** Denna enhet och dess primärbatterier kan återvinnas **
- DK** Denne enhed og dens primære batterier kan genbruges **
- PT** Este dispositivo e as suas pilhas primárias são recicláveis **



PAP

V2207