

Socket 4 : ON

LED:

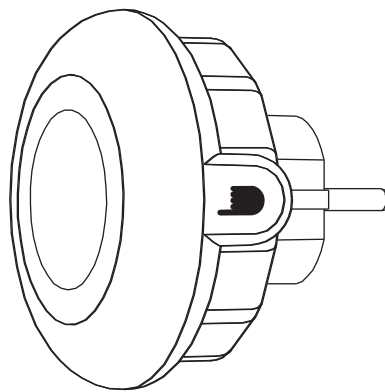

Socket 4 : OFF

LED: OFF

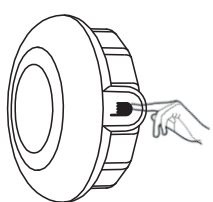
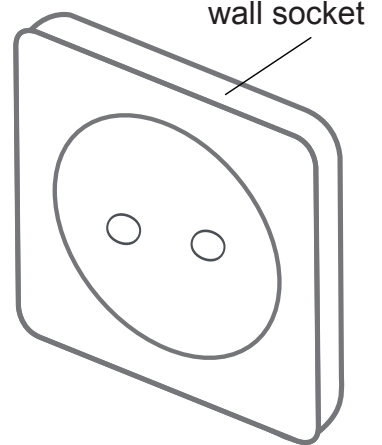

Tap 1: Light color - White

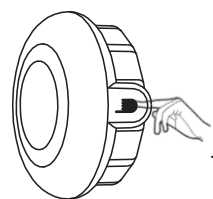

Tap 2: Light color - Green

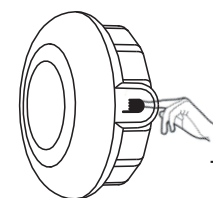

Tap 3: Light color - Blue

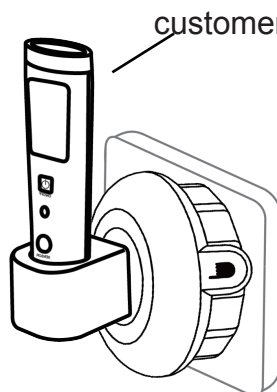

ON

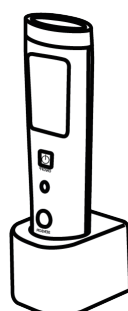

unplug

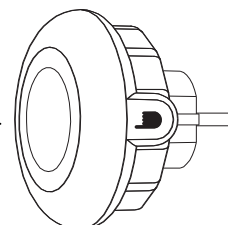

unplug

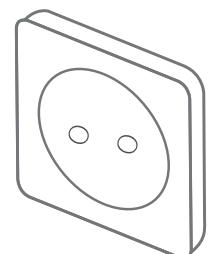

OFF